

RIM

INTELLIGENT. SIMPLE.

Yizumi devoted to making the production and management of rubber parts intelligent and simple.



Yizumi Rubber Machinery Co., Ltd.

Address: No.9-3 Shunchang Road, Shunde, Foshan, Guangdong 528300, China
TEL:+86-757-2926 5156 / 86-757-2926 2192 Email : rim@yizumi.com
www.yizumi.com

[DISCLAIMER]

- [1] YIZUMI reserves the right to modify the product description in the catalogue. Specification might be changed without prior notice.
 - [2] The picture in the catalogue is for reference only. The real object should be considered as final.
 - [3] The data in the catalogue is obtained from internal testing in YIZUMI laboratory.
- Please refer to the actual machine for the final data. YIZUMI reserves the right of final interpretation upon disputes and ambiguities.





Contents

About Us	01	Horizontal Series	29
Global Operation Capability	03	C-frame Series	31
Standardized Production, Strict Quality Management	05	Asian Series	33
R & D Capability and Achievements	07	Special Machines Series	37
Modular Concept, Flexible to Meet Customers' Needs	09	Compression Press Series	39
4,i Intelligent Manufacturing Solutions for Rubber Parts	11	Specialized Machines for Energy Industry	41
The 3 rd Generation Energy and Temperature Management System	13	LSR Cable Accessories Clamping Molding Machine	45
V5 Control and Management System	15	Air Spring Molding Machine	46
Injection Unit	17	Joint-free Rubber Track Molding Machine	47
Clamping Unit of General Models	21	Diamond Wire Saw Molding Machine	48
Industry Application	23	Molds	49
European Series	25	Yizumi Factory Outlet Service	51

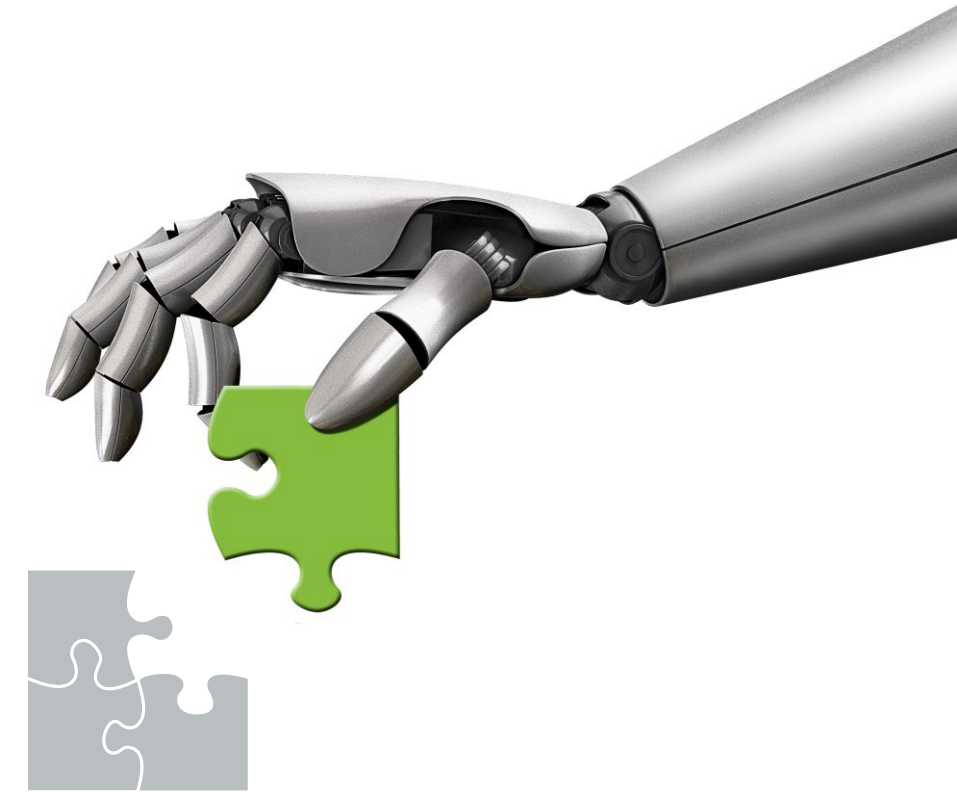

Intelligent. Simple.

Yizumi devoted to making the production and management of rubber parts intelligent and simple.

In order to meet customer needs and the market requirements for intelligence and modularization, we upgraded technology and adopted module design with the concept of modularization. Customers could receive customized, intelligent, and high cost-effective solutions by simple choices.



ABOUT US

SINCE 2002

Yizumi Holdings Co., Ltd. was founded in 2002, based in Guangdong, China, with a global perspective, focusing in the field of polymer and metal material molding. As a comprehensive equipment and solution provider, the company has technological know-how and integrated R&D, production, sales and service, and has set up plastic injection machine division, die casting machine division, rubber injection machine division, high speed packaging system division, and robotic automation system division.

Yizumi Rubber Machinery Co., Ltd., a holding subsidiary of Yizumi Group, was founded in 2009 and has drafted two National Standards for the Rubber Injection Machine Industry. Yizumi rubber injection molding machine ranks among the forefront in China market with a wide range of applications for molding all kinds of rubber parts in automobile, energy, electronics, railway transportation, medical care, household appliances. Combining advanced and comprehensive foundation technology from Yizumi group and considerable experience and specialized technology from the rubber machinery team, Yizumi can provide customized solutions to satisfy global customers' personalized needs.

Our Vision

To be a world-class molding equipment solution provider

Our Mission

Global expertise - Solutions for the world

Our Value

Think forward. Respond swiftly. Strive higher. Advance together.

Our Ideals

Sustainable, innovative technology for humankind

Global Business

Research, manufacture and service

5+ Global Innovation Platform

- Global Innovation Center
- Research Center for Polymer Processing
- Research Center for Die Casting and Metal Molding
- Research Center for Advanced Processing Technologies(DE)
- Research Center for Smart Manufacturing

12+ Technical Service Center

- Aachen Technical Center (Germany)
- Lippstadt Technical Center (Germany)
- Ohio Technical Center (U.S.)
- India Technical Center
- Joinville Technical Center (Brazil)
- São Paulo Technical Center (Brazil)
- Ho Chi Minh Technical Center (Vietnam)
- Hanoi Technical Center (Vietnam)
- Thailand Technical Center
- Russian Technical Center
- Mexico Technical Center
- Türkiye Technical Center

5+ Factories(China)

- China Gaoli Headquarters
- China Wusha No.1 Factory
- China Wusha No.2 Factory
- China Wusha No.3 Factory
- China Wujiang Factory

150+ Service Offices (Overseas)

Germany, U.S., France, Brazil, India, Korea, Vietnam, Turkey, Poland, Israel and so on.

2+ Factories(Overseas)

- U.S. Ohio Factory
- India Gujarat Factory

96+ Service Offices (China)

23+ Spare Parts Center (Overseas)





DEMAG 16t NO:16073016

DEMAG 10t

NO:16071025

YAZUHI

Standardized Production Strict Quality Management

Yizumi is committed to creating a globally advanced manufacturing platform and providing a reliable guarantee for production

Yizumi has been deepening the transformation and upgrade of the company. Through the connection of advanced European molding technology, and the establishment of R&D center and innovation center in China and abroad, Yizumi always introduces internationally advanced technology to strengthen customer's competitiveness.



Precise Manufacturing Platform

Yizumi is committed to building an internationally advanced manufacturing platform with multiple processing equipment worth tens of millions of dollars. This platform includes "OKUMA", "TOSHIBA", "MORI SEIKI" and "MAZAK" from Japan, TOS heavy boring and milling machining center from Czech Republic. Yizumi provides a powerful guarantee for the processing of key parts.

To significantly improve product's components accuracy, processing accuracy, and assembly accuracy, Yizumi is equipped with sophisticated original imported testing instruments and equipment, and always upholds high-quality standards.



Modular Production and Operation Model

Production with flexible single order production co-existed operation mode. Yizumi can meet the production requirements of both conventional and customized machines and further satisfy customers' demands for production quality, individualized needs, and date of delivery.

Strict Quality Management, Better Customer Satisfaction

- Following ISO9001:2015 Quality Management System;
- Implement standard operation procedures, guarantee the consistency of Yizumi products;
- Full implementation of self-process completion, to prevent the circulation of defective products;
- All staff participate in continuous improvement and innovation – Yizumi Kaizen System.



R & D Capability and Achievements

Connect Advanced Molding Technology Between China and Europe

Yizumi has multiple R&D centers worldwide. It cooperates with several institutes and universities in some of the key technological know-how to provide customers with intelligent and simple molding solutions for their rubber and polymeric materials.

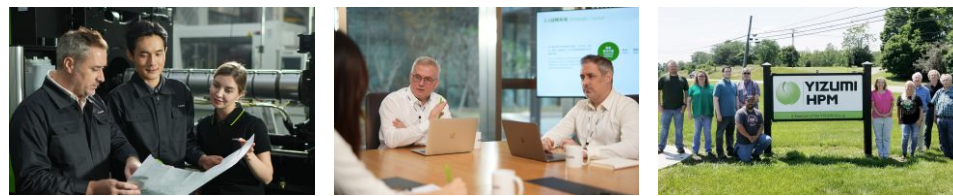

Six Core Achievements

Obtained multiple patents in technology over the past decade, Yizumi owns core technological know-how in the following six aspects:

- 1 | Intelligent manufacturing solutions
- 2 | The 3rd generation energy consumption and temperature control system
- 3 | Machine control and management system
- 4 | Injection unit
- 5 | Clamping unit
- 6 | Industry applications

Patents clarification as mentioned in the brochure:

Invention Patent (Patent Number):
200910261472.1 / 200910261471.7 / 200910261483.X / 201010503461.2 / 201610224910.7 / 201610224847.7 / 201610224282.2

Utility Model Patent (Patent Number):
201120389472.2 / 201120390769.0 / 201520500440.3 / 201520500375.4 / 201620344953.4 / 201620302225.7 / 201620408983.7 / 201620300982.0 / 201621182510.6 / 201721240286.6 / 201720974121.5 / 201721325974.2 / 201820894824.1 / 201820895686.9 / 201821672493.3 / 201920294713.1 / 201920294712.7 / 201920703181.2

Integrated Product Development (IPD)

Yizumi R&D team utilizes the in-depth functions of SolidWorks, Simulation, PLM design tools, and adopts the IPD model to help customers achieve greater differentiation at the lowest cost.



Modular Concept Flexible to Meet Customers' Needs

The concept of modularization is utilized to form a series of standard modules. By simple selection, suitable tailor-made solution can be made to meet customers' individual needs.

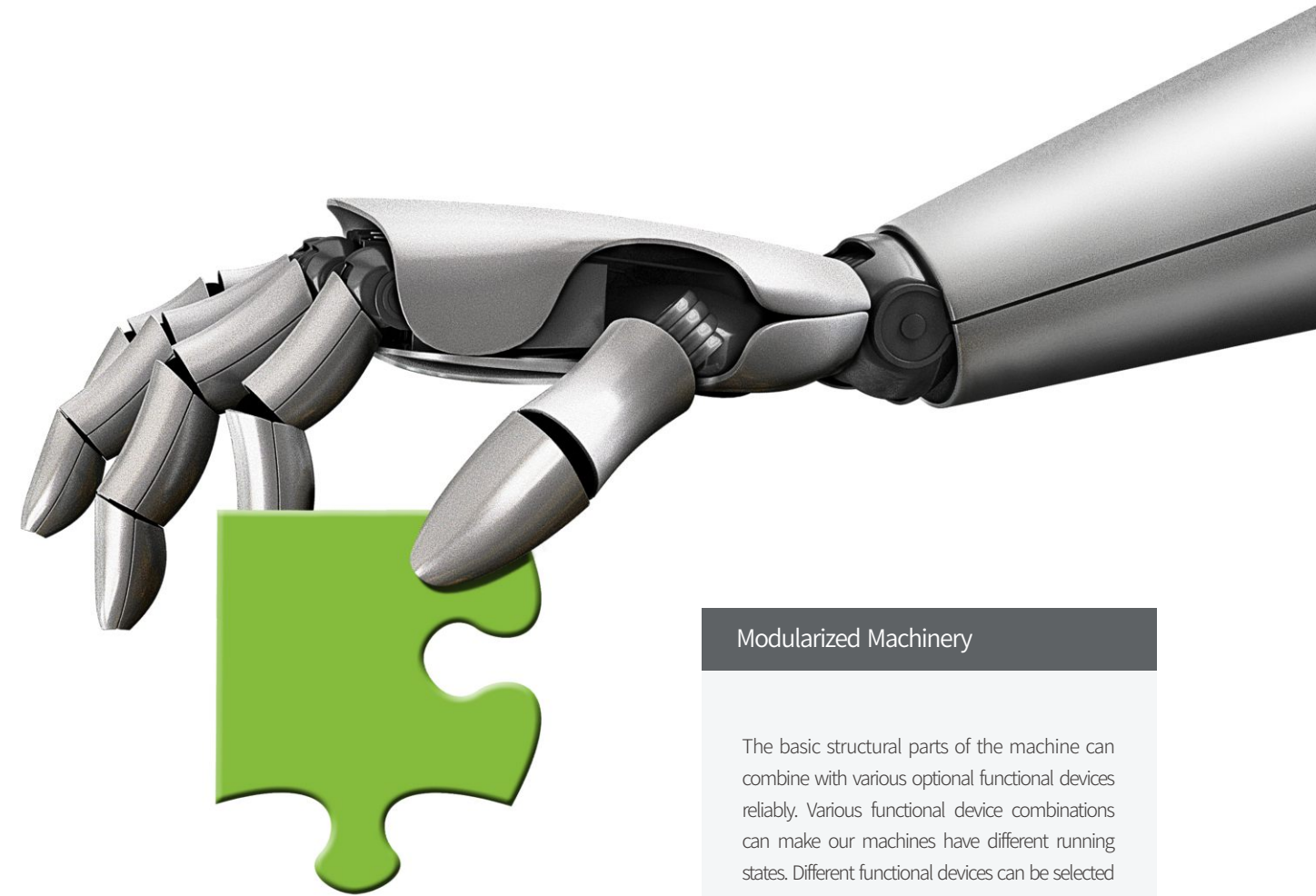
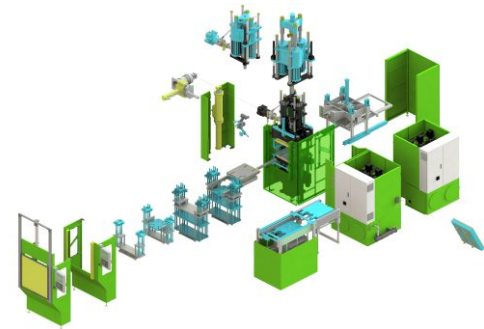

Modularized Machinery

The basic structural parts of the machine can combine with various optional functional devices reliably. Various functional device combinations can make our machines have different running states. Different functional devices can be selected according to customers' needs.

Modular Core Value Proposition

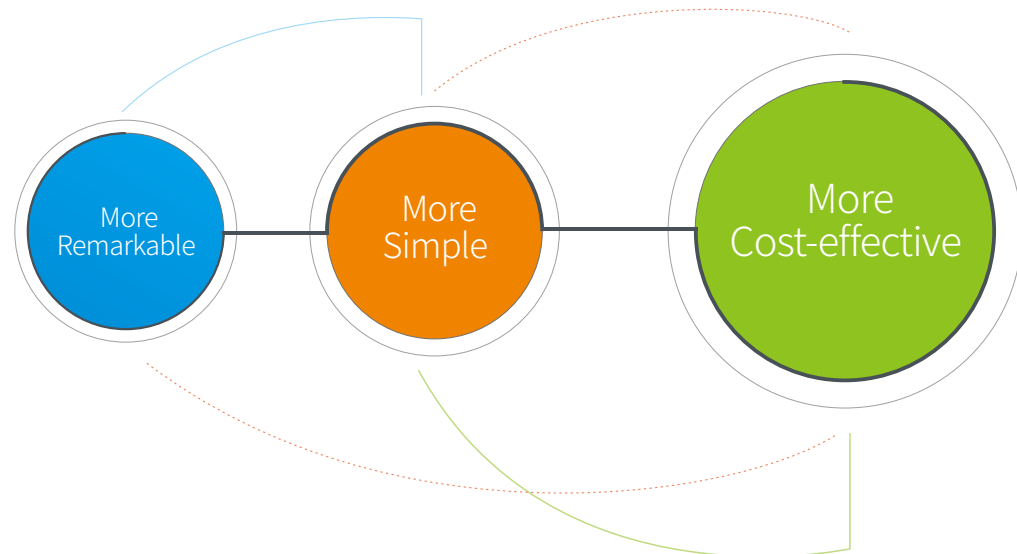

Modularized Program Control

The electrical system, hydraulic system, and other control modules can be selected freely according to customers' benefits.

Modularized Intelligent Interconnection

Customers can choose CMS, MES, and other intelligent systems according to their production management needs.



4.i Intelligent Manufacturing Solutions for Rubber Parts

Lean manufacturing (IE) and IATF 16949:2016 management requirements in the automotive industry are integrated into the design of intelligent equipment hardware & software, and industrial internet platform. Yizumi provides automotive customers with high-quality 4.i intelligent products to meet their various demands in the whole production process, meanwhile help customers to reduce manufacturing and management costs. This solution can be introduced to customers in other industries.

- Energy saving
- Modularization
- Intelligent
- Lean

i IE

- Measure cycle time through intelligent management system, formulate standard time.
- Man-machine operation analysis, assist managers to make improvement strategy.

i IATF 16949:2016

In accordance with IATF 16949:2016 management functions

- 4M change-point management
- ANDON
- Visual monitoring interface
- E-SOP

i Intelligent Equipment

High reliability, injection precision, injection time, temperature, etc. further optimized on the basis of 2nd generation machine; Control system upgraded with the intelligent management system. In addition to controlling the movement and performance of the equipment, it can implement equipment and production management.

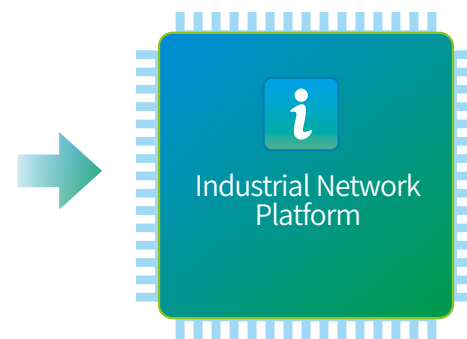

Deliver Real-time Service to Customers

Through YIZUMI e-service, you can enjoy 24-hours online support, mobile and rapid remote repair and maintenance as well. Regardless of where you are, it can deliver a rapid, convenient, online after-sales service, ensuring the equipment to be maintained in the best condition for the long term.



YiCMS(Condition Monitor System) is a production monitoring system that relies on Yi+ intelligent manufacturing platform, with the application of the latest generation ICT technologies of IOT (Internet of Things).

- Production Monitoring
- Production Statistics
- Fault Management
- Equipment Monitoring
- Forewarning Management
- Analysis Report
- Maintenance & Repair
- Process Monitoring



YiCMS can be easily upgraded to YiMES (Yi Factory Execution System)



- Production Management
- Order Management
- Production Monitoring
- ANDON Management
- Quality Management
- Forewarning Management
- Equipment Management
- Energy Management
- Mold Management
- Process Management
- Report & Display
- System Management



YiMES and YiCMS with IATF 16949:2016 quality management requirements implanted; through AI analysis and calculation of big data, remote diagnosis, predictive maintenance, risk forewarning and cost improvement can be realized and a smart enterprise brain is constructed.

The 3rd Generation Energy and Temperature Management System

Yizumi 3rd Generation Energy Consumption and Temperature Management System, Up to 50% Energy Saving

Deeply involved in the study of speed, performance and energy consumption of each action from drive, flow channels to load; Looking into each detail of heat conduction, heat convection to temperature field and energy consumption.

The 3rd Generation Energy-efficient Servo Technology

Optimized motor, oil pump, drive software, valve, oil channel, oil circuit control methods and other details, which saves 30%-60% energy compared to traditional hydraulic system.

Low Noise

About 20% reduction compared to 2nd generation hydraulic system.

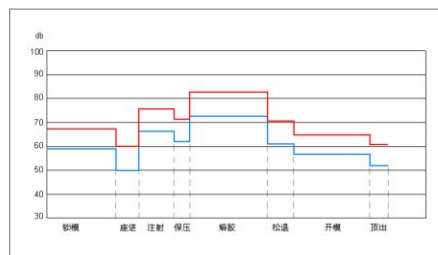

Strong Power

Tested on 200T machine, at full speed, full pressure, 5 minutes without overloading.



Rapid Response

Tested on 200T machine, the system response time is around 40ms.

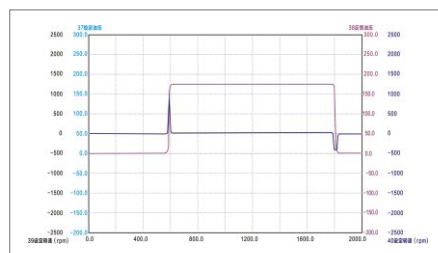

High Precision

Pressure & speed $Cmk \geq 1.67$, position precision improved by 50%.

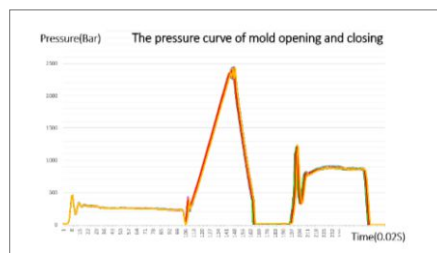

Low Load Design

Low load design for all motions. Tested on H200F machine, the energy consumption of fast mold opening and closing at full stroke and full cycle is less than 0.01kW·h.

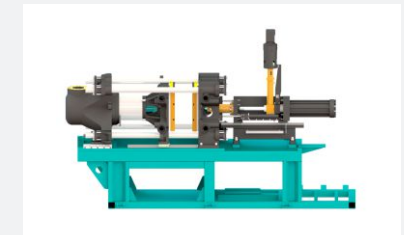

Hydraulic Oil Circuit Design and Components

Simulate oil demand of each movement, select low decline pressure pipes and valves; Adopt top brand components to prevent internal leakage and ensure stable performance.



Temperature Control Unit (some models only)

The accuracy of heating plate temperature is conducive to the improvement of product molding quality and cycle; while the energy consumption of heating accounts for more than 50% of the whole machine, about 25% less energy consumption after optimization.

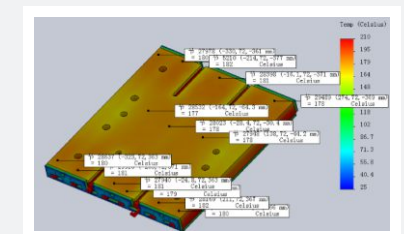

- Simulated heating plate design, more uniform temperature distribution.
- Not confined to heating plates, improve the heat transfer efficiency of every detail, reduce the energy loss caused by thermal convection.
- Durable heating insulation plate and heating cartridge.

V5 Control and Management System



Using Intel 4-core high-speed CPU, the performance of machine is greatly improved, and it also has 8 major function modules for equipment and production management. The data sheets of each function module can fully meet the requirements of IATF 16949:2016 or IE lean production. Machine operation, maintenance and management is intelligent and simple.

V5 Control Home Page



Network Function

Embedded website can be viewed directly, convenient for remote access & maintenance.

File Access

Machine file/data reading function; various data accessible.

Free Editable

Simple editing, suitable for complex process flow; Support machine subsequent function upgrade.

Quick Setting

One click to enter the process setting interface.

High Response

Powerful CPU, smooth running; High response to the software close-loop control of clamping, plasticizing, injection motions.

User-Friendly

21.5" screen, multi-touch, professional UI design and HMI design, graphic display, visual comfort, simple operation, ready to use.

Intelligent Clamping Control

- Clamping force holding effect self-learning;
- Based on injection and curing status analysis, automatic identify the clamping force, and provides automatic correction or prompts correction.

Multi-Platform Display

Based on HTML5 technology, it supports multi-panel and different browser access under the same network segment without interfering with each other.



V5 Management Home Page



Equipment Management System

- Intelligent monitoring of equipment operation status, abnormal alarm;
- Prompt maintenance reminding according to equipment operation data;
- Equipment resume;
- Automatically present OEE, MTBF, MTTR.

Determination of Key Parameter Cmk

- With Internet connection, real time monitor of the injection volume of each cycle;
- Periodically inspect machine operation status; remind maintenance if needed.

Daily Check of Machine

- Routine check reminding at the beginning of each shift, detailed checklist to avoid mistakes;
- Implement IATF 16949:2016, provide multi-language inspection items and periodic table;
- Abnormal alarm;
- Routine check by mobile phone (Online).

Energy Management

- Collect energy consumption data in accordance with IATF 16949:2016 energy management regulations;
- Formulate energy consumption standards for analysis and prediction;
- Abnormal alarm.

E-SOP

- SOP available at any time.

4M Change Point Management

- IATF 16949:2016 requirements;
- 4M control, abnormal alarm;
- Good production conditions;
- Barcode identification.

IE Time Study

- The working time can be measured through the management system, and the standard time can be set;
- Man-machine operation analysis.

Visual Monitoring Interface (ANDON)

- Provide real-time production QCD management data;
- ANDON alarm function;
- Production statistics.

Injection Unit

Fixed 3-cylinder type injection structure, simple, professional, accurate, durable, can meet a wide range of needs.

With intellectual property, the fixed 3-cylinder type injection structure successfully used in nearly 3000 machines worldwide, L3R and F3R series .

- During the plasticizing process, the injection cylinder does not move, and it is easy to accurately control the back pressure. Combined with the professional screw design, it has a wide range of applications. Conventional rubber, fluorine rubber, heat-sensitive rubber and high-hardness rubber can be easily processed;
- The injection unit adopts three cylinders and the injection piston is suspended freely. Free alignment, less wearing, less rubber leakage, stable injection volume;
- Easy to maintain and clean, the injection piston can be easily disassembled by removing only one bolt;
- Accurate back pressure + agile non-return device + software closed-loop control, which achieve accurate injection volume control;
- Injection unit can go up and down stably;
- "F.I.L.O" or "F.I.F.O" available.

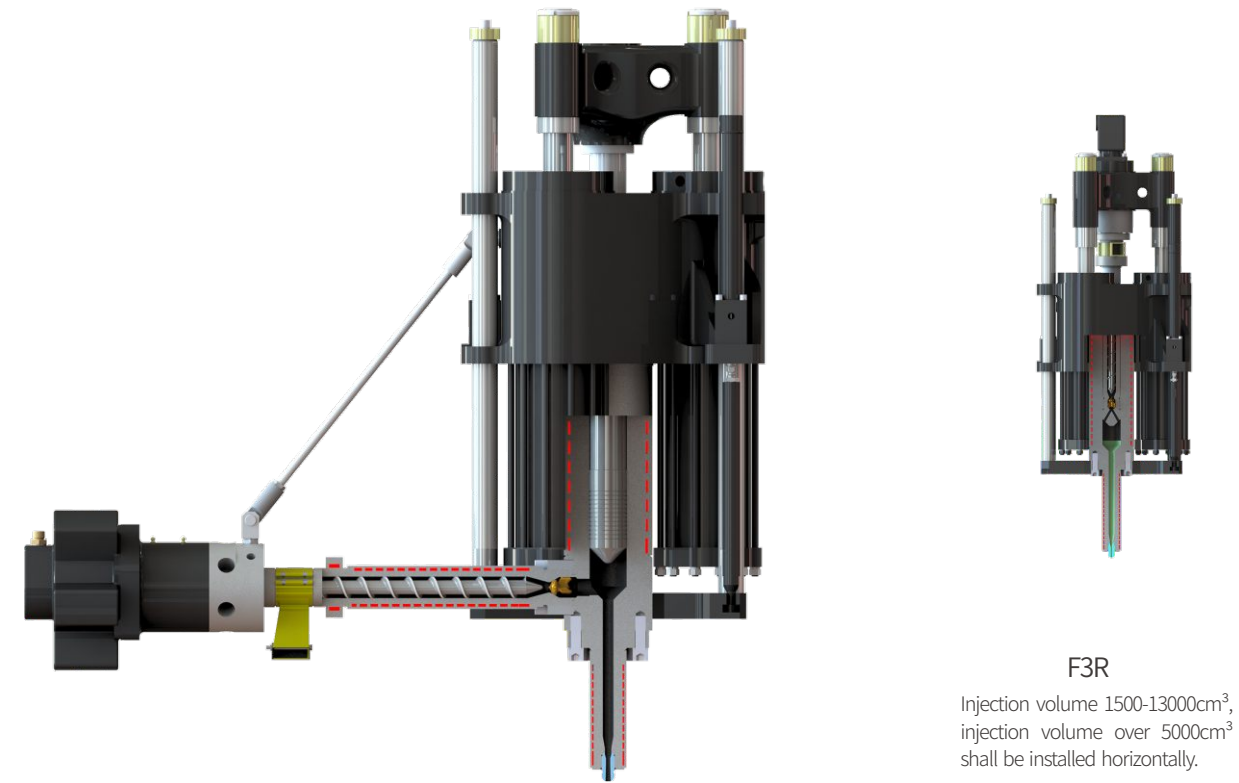

L3R
Injection volume 1000-12000cm³

F3R
Injection volume 1500-13000cm³,
injection volume over 5000cm³
shall be installed horizontally.

Note: 1. Injection Unit Code Meaning: L (F.I.L.O), F (F.I.F.O), 3 (3 Injection Cylinders), R (Rubber), L (LSR) – 1000 (Injection Volume 1000cm³), A (Injection Pressure Code)

2. ● Standard ○ Optional 3. YL2-V200/YL2-V300 injection pressure will be 10% lower than the data sheet when using the above injection units.

Series Code	L3R-1000A	L3R-2000A	L3R-3000B1	L3R-4000B1	L3R-4000C1	L3R-6000C1	L3R-6500D1	L3R-8000D1	L3R-8000D2	L3R-10000D1	L3R-12000D1	F3R-1500B1	F3R-3000B1	F3R-4000C1	F3R-5000C1	F3R-10000D1	F3RH-350	F3R-1500B2	F3R-2500B1	F3R-3300C1	F3R-4000C2	F3R-5000C1	F3R-4000D1	F3R-6000D1	F3R-8000D1	
Injection Unit	Injection Pressure/bar	2,600	2,200	2,000	1,900	2,100	2,100	2,500	2,000	2,500	2,000	1,700	2,200	2,100	2,500	2,000	1,700	3,750	2,200	2,100	2,000	2,000	2,000	2,400	2,000	2,000
	Screw Diameter/mm	40	40	50	50	50	50	65	65	65	65	65	35	40	45	45	55	32	40	40	50	50	50	50	55	55
	Size of Rubber Inlet/mm	50X20	50X20	65X20	65X20	65X20	65X20	80X35	80X35	80X35	80X35	80X35	50X20	50X20	65X20	65X20	70X30	50X20	50X20	50X20	65X20	65X20	65X20	80X35	80X35	
Clamping Unit	YL2-V200/YL2-V250	○	●	○								○	○				○	○	○							
	YL2-V300/YL2-V350	○	○	●	○							○	○				○	○		○						
	YL2-V450			○	●	○	○	○	○	○	○	○	○	○	○	○	○			○		○	○	○	○	○
	YL2-V600					○	●	○	○	○	○	○	○	○	○	○	○				○		○	○	○	○
	YL3-V280	○	●	○	○								○	○				○		○	○					
	YL3-V440			○	○	●	○	○	○	○	○	○	○	○	○	○	○			○	○		○	○	○	○
	YL3-V630					○	●	○	○	○	○	○	○	○	○	○	○				○		○	○	○	○
YL3-V800/YL3-V1200					○	○	○	○	●	○	○	○	○	○	○	○				○	○	○	○	○	○	

Injection Unit

According to different injection volume and application, Yizumi provides rubber injection system with different structures. Yizumi Group's world level plastic and LSR plastic injection technology can be combined into some machines to provide better solutions for certain specific products.

Other Plasticizing Injection Structures for Rubber or HTV



F1R

F1R — 1 injection cylinder, F.I.F.O, vertically or horizontally mounted.



S1R

S1R— 1 injection cylinder with special structure, vertically mounted.



L1R

L1R — 1 injection cylinder, F.I.L.O, vertically mounted.

Plasticizing Injection Structure for Plastics and LSR



F1L

F1L — for LSR molding, 1 injection cylinder, F.I.F.O, vertically or horizontally mounted.



F1P

F1P — for plastic molding, 1 injection cylinder, F.I.F.O.



F2L

F2L— for LSR molding, F.I.F.O, 2 injection cylinders, vertically or horizontally mounted.



F2P

F2P— 2 injection cylinders, F.I.F.O, vertically or horizontally mounted.

Note: 1. Injection Unit Code Meaning : L (F.I.L.O), F (F.I.F.O), 3 (3 Injection Cylinders) R (Rubber), P (Plastic), L (LSR) -1000 (Injection Volume 1000cm³) (Injection Pressure Code)

Series Code	L1R-10000A	L1R-15000B	L1R-20000B	L1R-18000C	L1R-25000C	L1R-32000D	L1R-50000D	L1R-38000E	L1R-50000E	L1R-60000E	S1R-50A	S1R-170A	S1R-230A	S1R-300B	S1R-500B	S1R-630C	F1R-500	F1R-1000	F1P-70	F1P-120	F1P-200	F2P-250	F2P-370	F2P-550	F1L-40	F1L-130	F1L-250	F2L-160	F2L-200	F1R-250	F1P-170	F2P-160	F1L-190	
Injection Pressure / bar	1260	1260	1260	1260	1260	1260	1260	2000	1520	1260	3000	1800	1580	2200	1700	1900	2300	2300	2000	2200	1800	1700	1600	1700	1400	1400	1500	1850	1400	2100	1500	2500	2200	
Piston Diameter / mm	125	150	150	170	170	220	220	192	220	241	22	30	32	35	40	48	50	65												36				
Screw Diameter / mm	65	65	65	65	65	90	90	90	90	90		30			40		40		26	35	40	43	48	53	22	35	40	35	40	30		35	35	
Size of Rubber Inlet / mm	HTV	HTV	HTV	HTV	HTV	HTV	HTV	80X35	HTV	HTV		35×21.5			50×20		50×20											LSR		HTV	TEP, TPU	TEP, TPU	LSR	

Clamping Unit of General Models

Yizumi provides more than 10 kinds of clamping structures with intellectual property, which can easily meet the molding and operation requirements of various products.

Applied the latest 3D finite element simulation software in designing and utilized advanced casting technology, the platen is of lightweight while excellent high-strength and low-load. Big clamping structure facilitates the arrangement of various demoulding devices.

Multiple clamping structures own independent intellectual property rights.

There are upward closing structure (D1) and downward closing structure (D7) available for 4-column 3-step closing system.

- Simple structure, stable and rapid movement; low load and high energy efficiency;
- Low operation height;
- Durable sealing, less hydraulic oil consumption;
- Can meet customer's requirement for different opening stroke;
- For particularly long product, such as insulators, a downward closing structure is adopted to ensure the insert positioning fixed and at the same time have a lower operating height.



D1
D1 upward closing structure

D7
D7 downward closing structure



D2
Structure: 4-column 2-step upward closing;
Features: Simple, full stroke clamping available.



D4
Structure: C-frame 2-step downward closing;
Features: Column free structure, 3-side operation accessible, double sliding plate or rotary table available to achieve double lower mold exchange; Downward closing structure, inserts will not move.

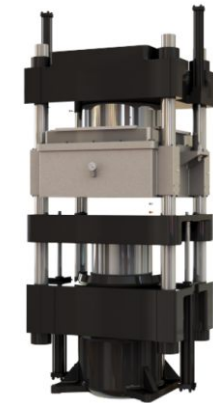

D6
Structure: 4-column 2-step upward closing with vacuum chamber;
Features: Avoid air trapping, ideal for products with complex structure, no need for venting during injection, less flash.



D3
Structure: 4-column 2-step horizontal closing;
Features: Design concept from European technical team, simple, high rigidity, agile movement, low load.



D5
Structure: 2 platens, 2-step closing with 4 clamping cylinders horizontally arranged;
Features: Design concept from European technical team; Mold with even force distribution; Consistent product size accuracy and small footprint.

Industry Applications

Based on the know-how of product molding technology, different combinations of standard modules can be selected to form a large number of professional solutions. These solutions can meet customers' diverse needs economically and efficiently, creating an ideal TCO. Many of the solutions are the first in the world, and become the benchmark in the industry .

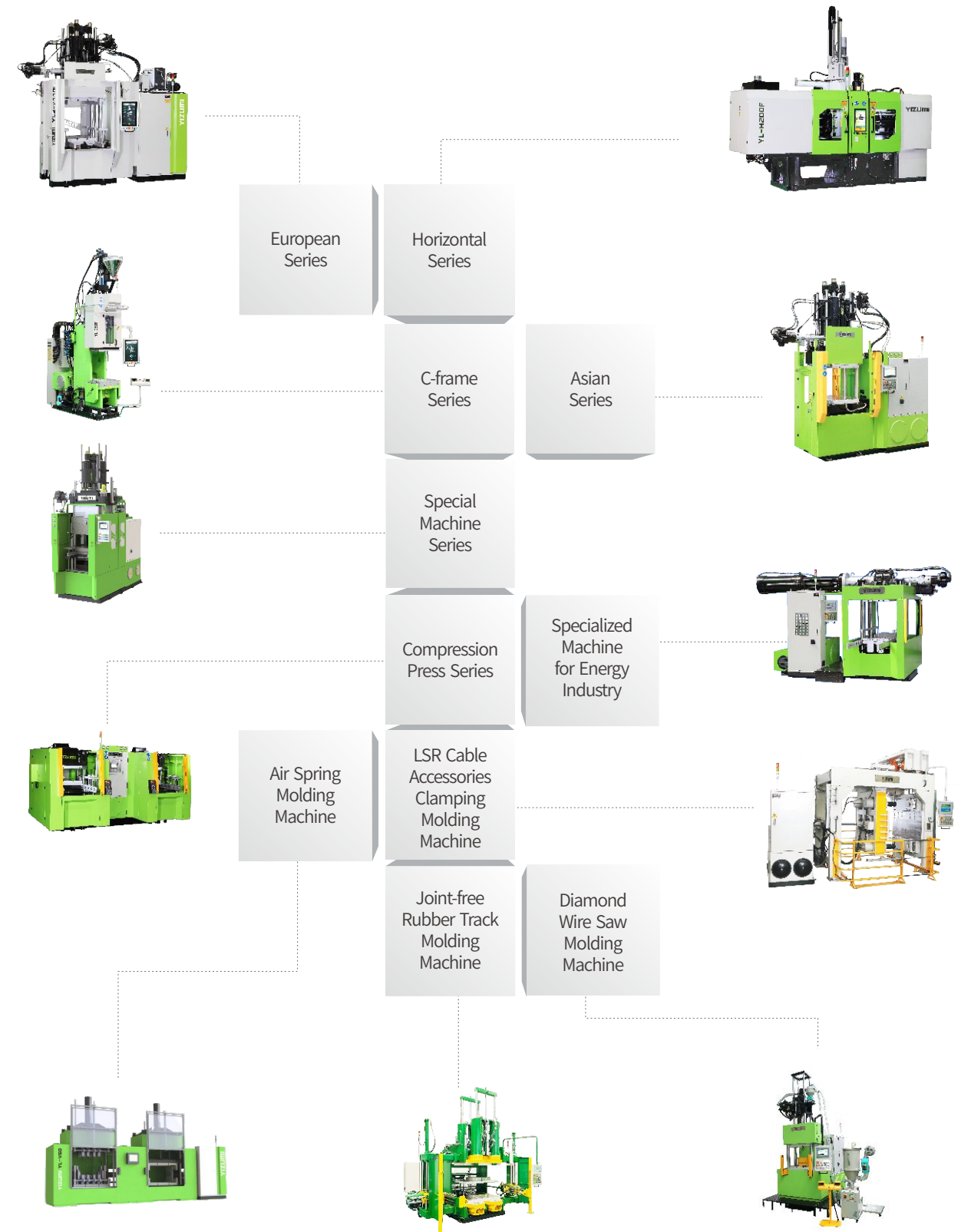
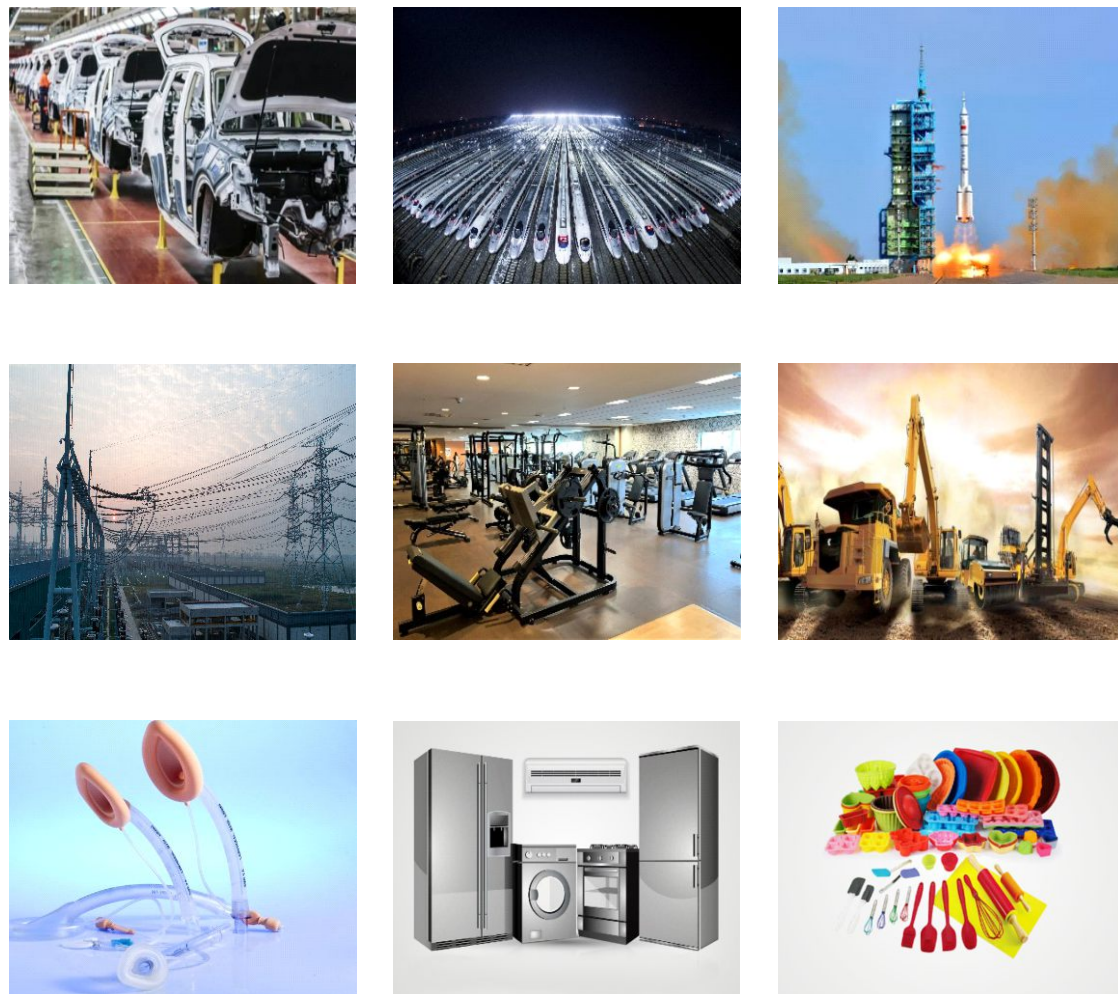

YIZUMI





European Series

Benchmark European Standards, Deep Modular, Cost-Effective

YL3-VL/F is the 3rd Generation European Series Injection Machine

It is an intelligent machine that meets requirements of Industry 4.0 for rubber industry. The machine uses new core technology, more precise and reliable, and has "smart" components. Simple operation, less maintenance and easy management. More comprehensive and accurate data supports intelligent manufacturing, thereby helps customers easily reach their business goals.

Standard Configuration

- ① L3R injection unit (except for 100T)
- ② D1 clamping structure (100T and 280T adopt D2 clamping structure)
- ③ V5 control and management system
- ④ The 3rd generation energy and temperature management system
- ⑤ Ergonomic design
- ⑥ CE safety standard
- ⑦ ID card reader with different permission level
- ⑧ Bar code scanning function
- ⑨ OPC communication function
- ⑩ Screw speed display and control
- ⑪ Sensitive proportional digital back pressure control
- ⑫ Material shortage alarm function



YL3-V440L

European Series



V100F



V280L



V550L



V630F



V1200L

Industry Application



Machine Specifications

	Unit	YL2-V100F	YL2-V280L/F	YL2-V440L/F
Clamping Structure		D2	D2	D1
Clamping Force	kN	1000	2800	4400
Closing Stroke	mm	450	500	600
Heating Plate Size	mm	320x410	560x630 / 670x630 / 560x780 / 670x780	700x800 / 810x1000
Heating Plate Heating Power	kW	10	17/21/22/26	28/38
Standard Injection Unit	cm ³	F1R-500	L3R-2000A1	L3R-4000C1
Optional Injection Unit	cm ³	F1R-1000	F1R-500 / L3R-1000A1 L3R-3000B1 / L3R-4000B1 F3R-1500B1 / F3R-3000B1	L3R-3000B1 / L3R-4000B1 / L3R-4000C2 / L3R-5000C1 L3R-6000C1 / L3R-6500D1 / L3R-8000D1 / F3R-1500B1 F3R-3000B1 / F3R-4000C1 / F3R-5000C1

	YL3-V280L/F	YL2-V550/630L/F	YL2-V800/900L/F	YL2-V1200L/F
Clamping Structure	D1	D1	D1	D1
Clamping Force	2800/3000	5500/6300	8000/9000	12000
Closing Stroke	600	700	800	850
Heating Plate Size	560x630 / 670x780	810x1000 / 900x1000	1100x1350	1200x1600 / 1300x1300
Heating Plate Heating Power	17/26	38/45	65	70/70
Standard Injection Unit	F3R-4000C	L3R-6000C1	L3R-8000D1	L3R-8000D1
Optional Injection Unit	F1R-500 / L3R-1000A1 / L3R-3000B1 L3R-4000B1 / L3R-4000C1 / L3R-6000C1 F3R-1500B1 / F3R-3000B1	L3R-4000C1 / L3R-4000C2 / L3R-5000C1 / L3R-6500D1 L3R-8000D1 / L3R-8000D2 / L3R-10000D1 / F3R-4000C1 / F3R-5000C1 / F3R-10000E1	L3R-4000C1 / L3R-4000C2 / L3R-5000C1 L3R-6000C1 / L3R-6500D1 / L3R-8000D2 L3R-10000D1 / F3R-4000C1 / F3R-5000C1	L3R-4000C1 / L3R-4000C2 / L3R-5000C1 L3R-6000C1 / L3R-6500D1 / L3R-8000D2 L3R-10000D1 / F3R-4000C1 / F3R-5000C1



European Series

Benchmark European Standards, Deep Modular, Cost-Effective

Simple Choice, High Adaptability

Meeting the mainstream European mold installation and demolding requirements. Dozens of precise modules, flexible combination. One set of advanced software, simple editing. All these quickly meet diverse needs.

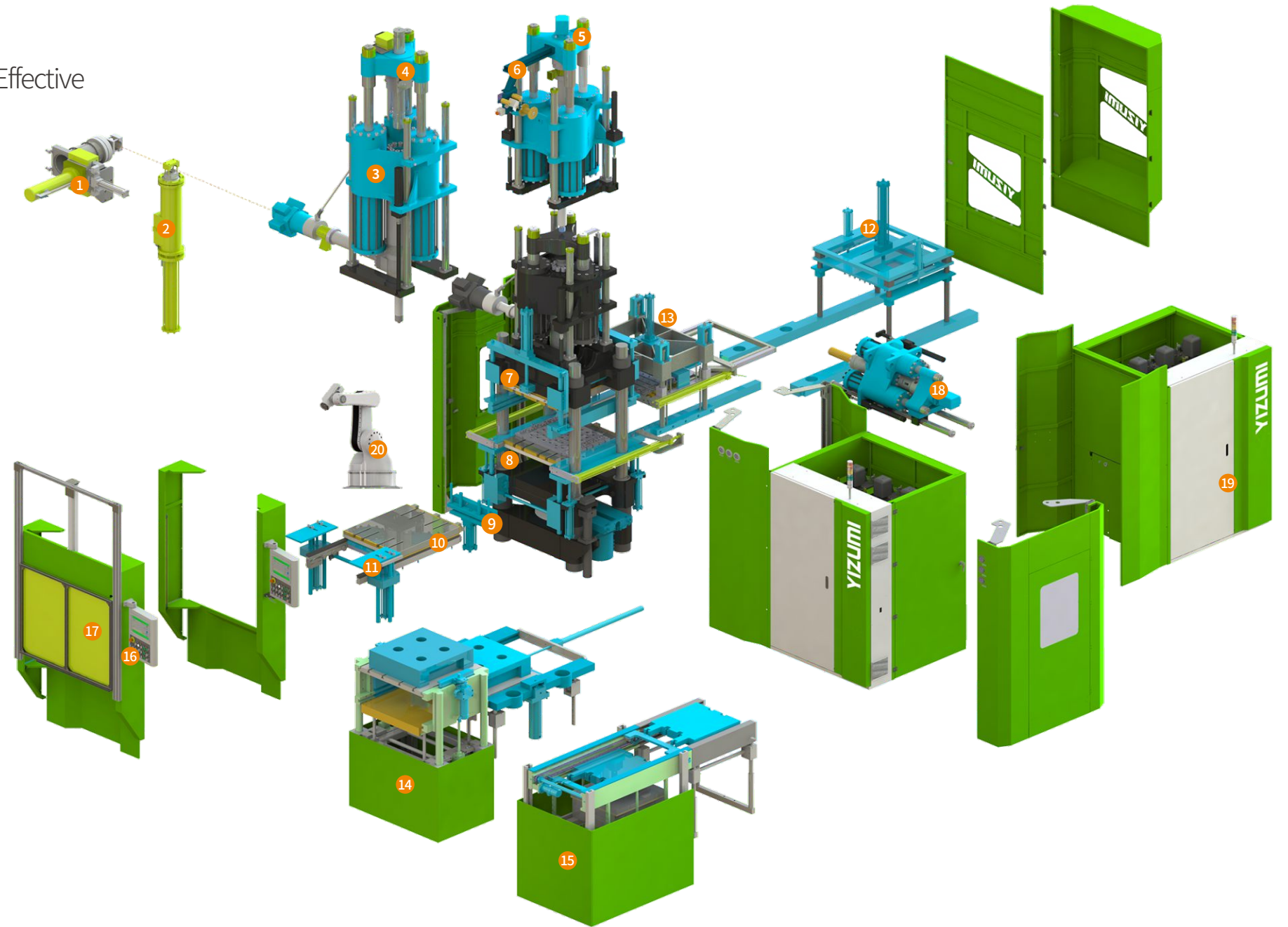

Main Option Devices

- ① Open gate silicone stuffer
- ② Side open silicone stuffer
- ③ Injection piston damper device
- ④ L3R Injection unit (non-standard injection volume)
- ⑤ F3R injection unit
- ⑥ Strip compound feeding device
- ⑦ Top hydraulic mold separator
- ⑧ Bottom hydraulic mold separator
- ⑨ Center Ejector
- ⑩ Lower mold sliding device
- ⑪ 2RT
- ⑫ Rear side downward ejecting device
- ⑬ Auto ejecting device for bushing
- ⑭ Double lower or middle mold non-synchronous exchange (suitable for thick mold)
- ⑮ Double lower or middle mold synchronous exchange
- ⑯ B & R control system with 10" touch screen or siemens control system with 9" HD screen
- ⑰ Pneumatic door
- ⑱ F3R 2nd injection unit (two compounds)
- ⑲ Oil tank at rear side(not for 100T and 280T)
- ⑳ Robotic system
- ㉑ Manual double middle mold exchange device
- ㉒ Regular motor + variable displacement pump



③ Injection piston damper device

Piston can be fully pulled out for quick cleaning without removing bolts.



⑬ Auto ejecting device for bushing

Downward automatic ejector, suitable for bushings or similar products, products can be transported to the front of machine through conveyor belt, convenient for product checking.



⑮ Double lower or middle mold synchronous exchange device

Synchronic mold exchange, outer mold has dedicated heating plate, suitable for thin mold which needs long demolding time.





Horizontal Series

Clamping Unit Design Oriented From Europe

The European technical team is involved in the design. The machine's consistency, reliability and speed performance is according to high standards to ensure the stability of fully automated production quality; thus greatly improving production efficiency and reducing labor costs.

In addition to processing rubber materials, injection units for processing plastics, LSR, and HTV are also available.

Standard Configuration

- ① Adopt D3 clamping unit
- ② V5 control and management system
- ③ F1R injection unit
- ④ Screw speed display and control, sensitive proportional digital back pressure, material shortage alarm, metering inlet temperature control
- ⑤ The 3rd generation energy and temperature management system
- ⑥ CE safety standard
- ⑦ Hydraulic center ejector



YL-H200F single cylinder
(D3 clamping unit)

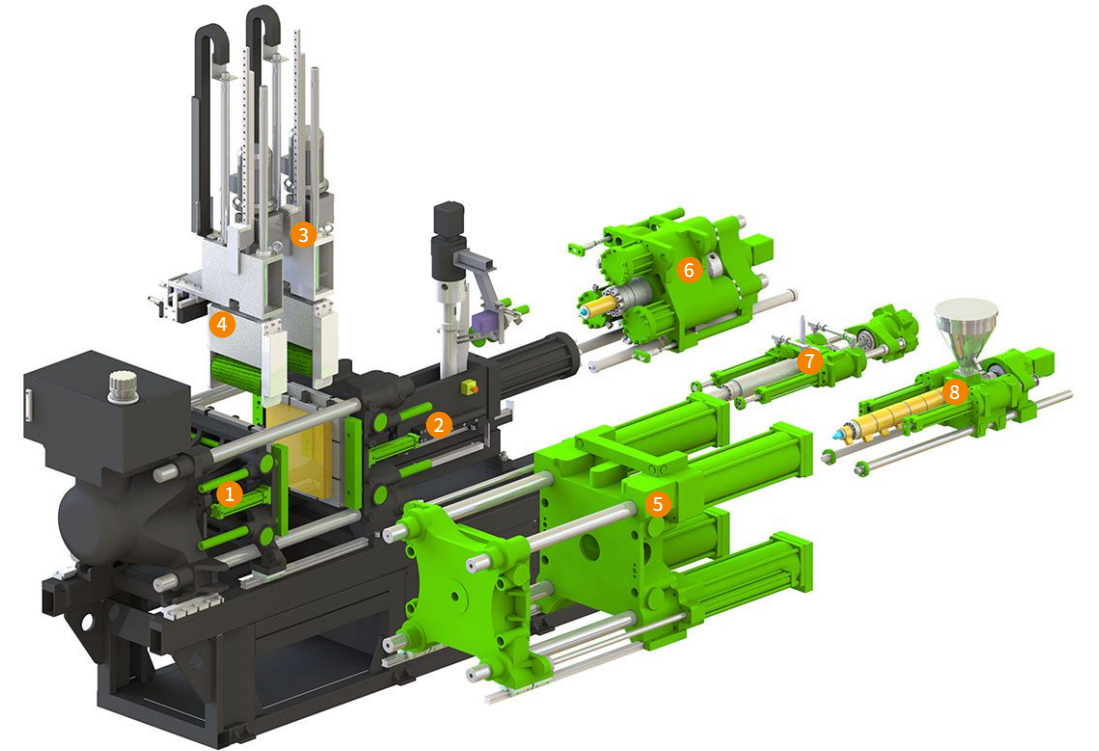

YL-H200F 4-cylinder
(D5 clamping unit)

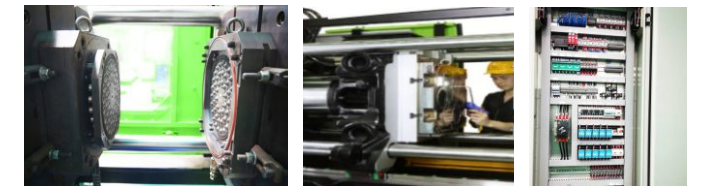

Machine Specifications

Unit	YL-H200F	YL-H300F
Clamping Force	kN 2000	3000
Closing Stroke	mm 500	500
Heating Plate Size	mm 550x550	600x600 / 650x650
Standard Injection Unit	cm ³ F1R-500	F1R-1000
Optional Injection Unit	cm ³ Rubber: F1R-500 / F1R-1000 / F3R-1500 / F3R-3000 / Plastic: F1P-200 / F2P-250 / F2P-370 / F2P-500 / LSR: F2L-160 / F2L-200	

Main Option Devices

- ① Movable platen hydraulic separator
- ② Fixed platen hydraulic separator
- ③ Single brush system
- ④ Double brush system
- ⑤ D5 4-cylinder clamping unit
- ⑥ F3R-Rubber injection unit
- ⑦ F2L-LSR injection unit
- ⑧ F2P-Plastic injection unit
- ⑨ Siemens control system with 9" HD screen, V4.0 control software
- ⑩ Regular motor + Variable displacement pump energy saving hydraulic system
- ⑪ Solid silicone stuffer



C-frame Series

Small Size High Precision Rubber Injection Machine

High precision, small injection volume plastic, rubber, LSR injection units available, especially suitable for the production of small precise parts with inserts and profile jointing.

Standard Configuration

- ① B & R control system with 10" screen
- ② Screw speed display and control
- ③ Sensitive proportional digital back pressure control
- ④ Material shortage alarm
- ⑤ CE safety standard
- ⑥ The 3rd generation energy and temperature management system
- ⑦ D4 clamping structure



YL-C50L



YL-C50F

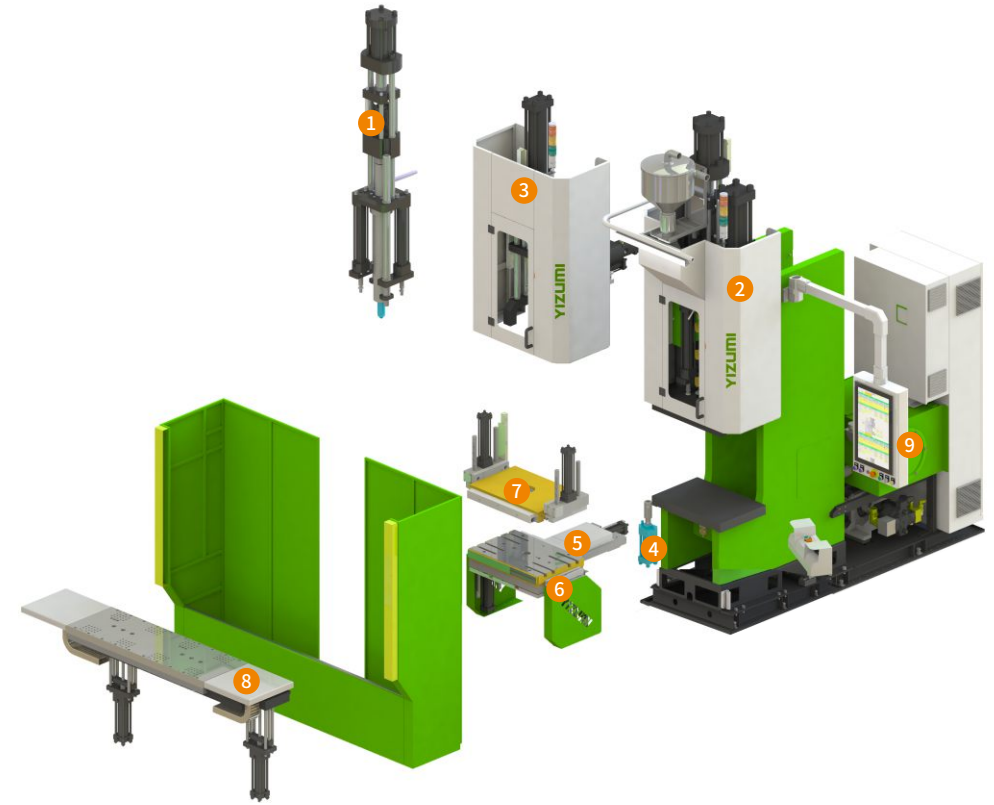

Industry Application



Machine Specifications

	Unit	YL-C30L/F	YL-C40L/F	YL-C50L/F	YL-C80L/F	YL-C100L/F	YL-C160L/F
Clamping Force	kN	300	400	500	800	1000	1600
Closing Stroke	mm	460	460	460	460	460	460
Platen Size (width x length)	mm	500x400 / 600x400			600x400 / 700x500		800x700
Min. Mold Height (rubber)	mm	170	190	190	310		310
Min. Mold Height (plastic)	mm	250	270	270	390		390
Optional Injection Unit	cm ³	Rubber: S1R-50A / S1R-170A / S1R-230A / S1R-300B Plastic: F1P-120B / F1P-170B LSR: F1L-90 / F1L-250			Rubber: S1R-230A / S1R-300B / S1R-500B / S1R-630C Plastic: F1P-120B / F1P-170B / F2P-550D LSR: F1L-190 / F1L-250		

Main Option Devices

- ① F1L-LSR injection unit
- ② F1P-Plastic injection unit
- ③ S1R-Rubber injection unit
- ④ Center ejector
- ⑤ Sliding device
- ⑥ Bottom hydraulic mold separator
- ⑦ Top hydraulic mold separator
- ⑧ Double lower mold exchange system(left-right)
- ⑨ Double lower mold rotary system
- ⑩ B&R control system with 21.5" touch screen
- ⑪ Closed-loop servo valve controls injection accuracy
- ⑫ Preheating function of hydraulic oil



Asian Series

In-depth Modular Design Application in Rubber Injection Machine Industry

YL2-VL/F Asian Series Injection Machine

The high bed structure compatible with typical Asian mold design. With advanced design concept, advanced processing technology, the Asian series is widely applicable and cost-effective. It can meet the needs of customers in different industries with low investment and excellent performance.

Standard Configuration

- ① Siemens control system with 10" HD touch screen, V4.0 control software
- ② L3L/F injection unit
- ③ D3 clamping structure (D1 for 600 T)
- ④ Top brand hydraulic pump, directional valve, seal
- ⑤ China GB safety standard

Note:

200T, 300T and 600T with oil tank on the right side

250T, 350T and 450T with oil tank at the rear side



YL2-V300L

Asian Series



YL2-V300F



YL2-V200L (with silicone stuffer)



YL2-V250L



YL2-V450L

Industry Application



Machine Specifications

	Unit	YL2-V200L/F	YL2-V250L/F	YL2-V300L/F	YL2-V350L/F
Clamping Structure		D2	D2	D2	D2
Clamping Force	kN	2000	2500	3000	3500
Closing Stroke	mm	480	480	500	500
Heating Plate Size	mm	550x550 / 550x650 / 550x750 / 600x650 / 600x750		600x650 / 600x800 / 650x650 / 650x750 / 700x750	
Heating Plate Heating Power	kW	14 14 18 16 18		16 20 18 20 22	
Standard Injection Unit	cm ³	L3R-2000A1		L3R-3000B1	
Optional Injection Unit	cm ³	L3R-1000A1 / L3R-3000B1 F3R-1500B1 / F3R-3000B1		L3R-1000A1 / L3R-2000A1 / L3R-4000B1 / L3R-4000C2 L3R-5000C1 / L3R-6000C1 / F3R-1500B1 / F3R-3000B1	

	YL2-V450L/F	YL2-V600L/F
Clamping Structure	D2	D1
Clamping Force	4500	6000
Closing Stroke	600	700
Heating Plate Size	700x800 / 700x1000 / 810x900 / 810x1100	750x850 / 850x850 / 900x1000 / 900x1100
Heating Plate Heating Power	28 34 34 40	30 34 42 48
Standard Injection Unit	L3R-4000B1	L3R-6000C1
Optional Injection Unit	L3R-3000B1 / L3R-4000C1 / L3R-4000C2 / L3R-5000C1 / L3R-6000C1 L3R-6500D1 / L3R-8000D1 / F3R-1500B1 / F3R-3000B1 / F3R-4000C1 / F3R-5000C1	L3R-4000C1 / L3R-4000C2 / L3R-5000C1 / L3R-6500D1 / L3R-8000D1 L3R-8000D2 / L3R-10000D1 / F3R-4000C1 / F3R-5000C1



Asian Series

In-depth Modular Design Application in Rubber Injection Machine Industry

Standard Modular, Flexible Solutions

In order to match with the mainstream Asian demolding requirements, we adopt high-bed clamping structure with larger column spacing to facilitate the flexible combination of various complex demolding devices and other optional functions. It can satisfy the needs of customers in different industries worldwide for high efficiency while low investment.

Main Option Devices

- ① Open gate silicone stuffer
- ② Side open silicone stuffer
- ③ L3R injection unit(non-standard injection volume)
- ④ F3R injection unit (F.I.F.O)
- ⑤ Strip compound feeding device
- ⑥ Top hydraulic mold separator
- ⑦ Bottom hydraulic mold separator
- ⑧ Lower mold sliding device
- ⑨ 4RT
- ⑩ 3RT double lifter
- ⑪ 3RT with one ejector and one lifter
- ⑫ 2RT
- ⑬ Downward ejecting device
- ⑭ Double lower/middle mold synchronic exchange (suitable for thin mold)
- ⑮ Pneumatic door
- ⑯ Siemens control system with 9" touch screen
- ⑰ B&R control system with 21" screen, V5 control and management system
- ⑱ CRB
- ⑲ The 3rd generation servo energy saving pump
- ⑳ Mold plate clipping device
- ㉑ Ejecting device in clamping area
- ㉒ Bottom mechanical mold separator
- ㉓ Top mechanical mold separator
- ㉔ Mold tilting device
- ㉕ Side core puller
- ㉖ Double lower or middle mold non-synchronic exchange (suitable for thick mold)
- ㉗ Manual double middle mold exchange device

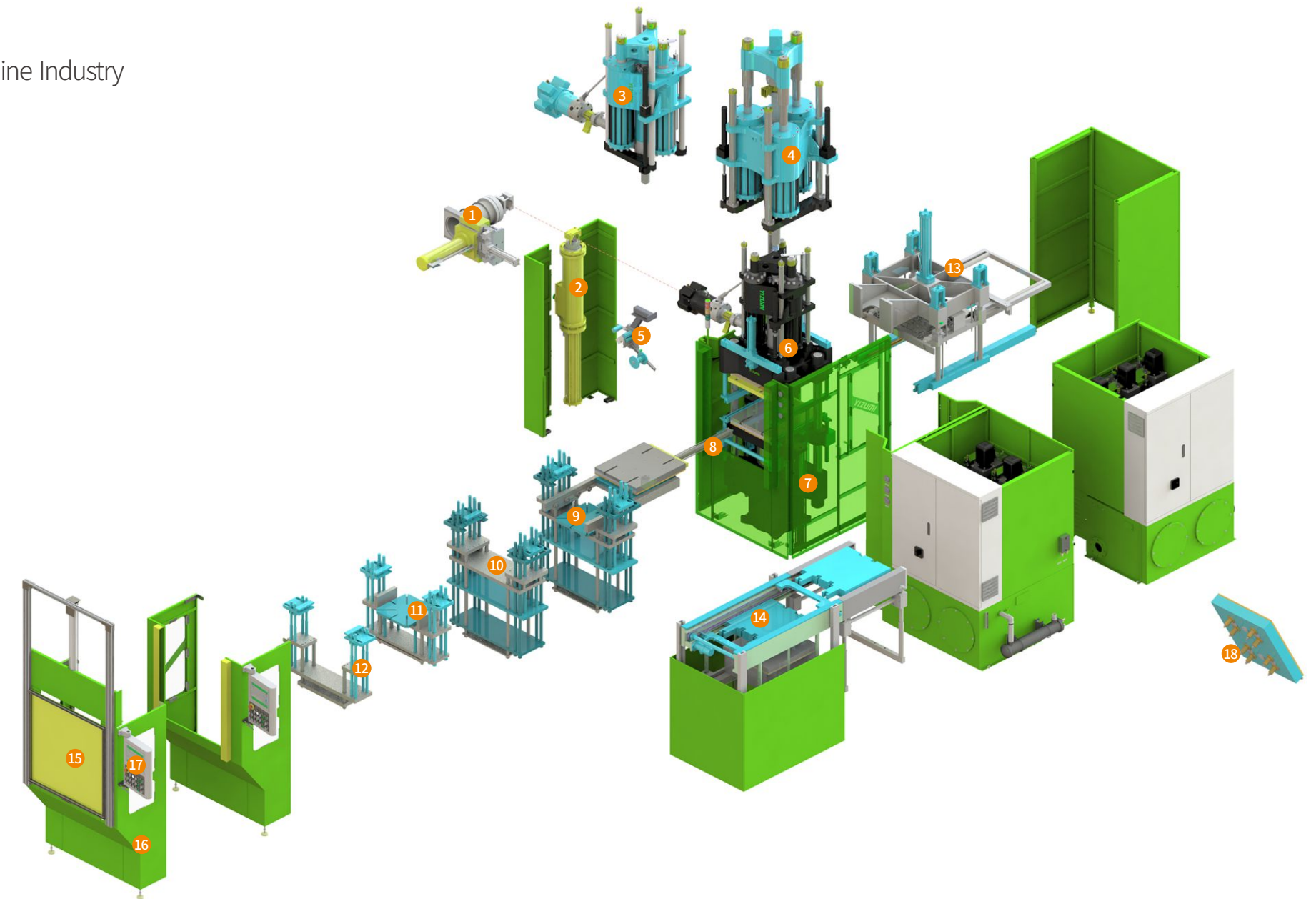

⑨ 4RT + mold tilting device

⑩ 3RT double lifter + mold tilting device

⑪ 3RT one lifter + one ejector

⑫ 2RT

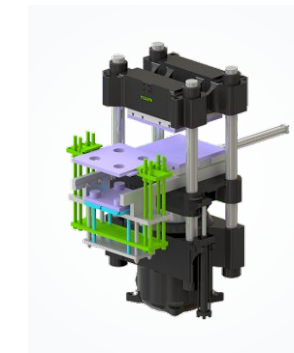
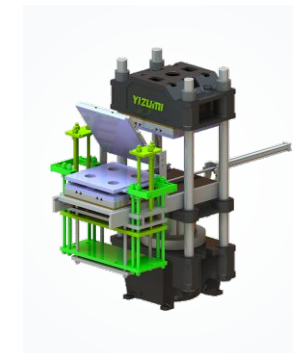
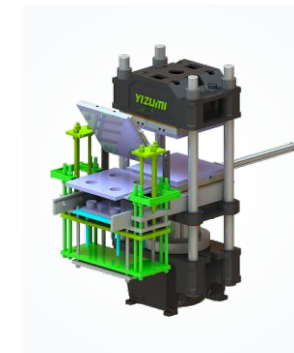



Special Machines Series

Tailor-made Solutions for Customers

Vacuum Chamber Injection Machine

- It is suitable for molding all kinds of products which have air entrapment problem or venting difficulty or venting not allowed
- Vacuum can be quickly achieved; accurate setting, display and control
- No venting movement, less flash, can realize automatic production



YL-VV350L



YL-VV450F
(Dual-material injection machine)



Injection Machine with Large Injection Volume

- Suitable for molding products with large injection volume
- High plasticizing efficiency, accurate plasticizing temperature control, no scorching, large part with temperature-sensitive rubber can be easily molded
- Ideal machine for molding medium voltage, high voltage and extra-high voltage cable accessories with EPDM material



YL2-V300L
(Injection volume 6000cm³, injection pressure 1900bar)



YL2-AB630F
(Injection volume 10000cm³, injection pressure 1700bar)



YL2-AB1200L
(Injection volume 40000cm³, injection pressure 1900bar)

PS
SERIES

Compression Press Series

Simple Molding Solution for Rubber Parts

- Low energy consumption design, high strength environmental friendly insulation plate
- Mold temperature maintained while heating plate sliding out
- Faster running speed
- Siemens control system
- International well-known electrical, hydraulic and sealing components



YL-V350



YL-VV450
(Vertical side plate clamping structure)



YL-V1000
(Vertical side plate clamping structure)



YL-VV350

Main Option Devices

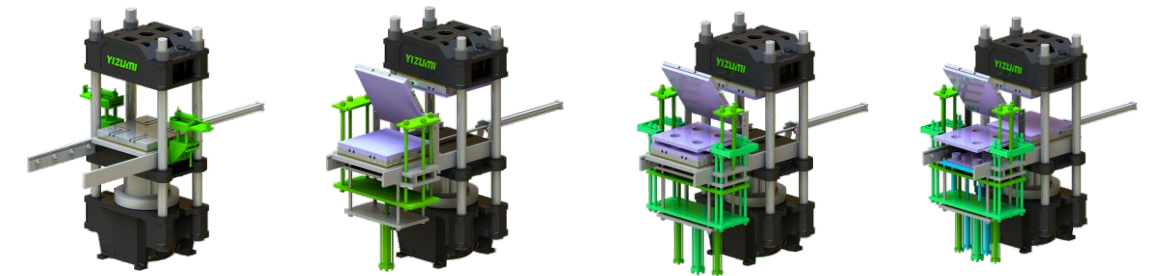

- 1 Clipping device + lower mold sliding device
- 2 2RT + tilting device
- 3 3RT double lifter + tilting device
- 4 4RT + tilting device

Machine Specifications

	Unit	YL-V200	YL-V250	YL-V350	YL-V1000	YL-VV200	YL-VV250	YL-VV350	YL-VV450
Clamping Force	kN	2000	2500	3500	10000	2000	2500	3500	4500
Closing Stroke	mm	250	250	250	660	250	250	250	870
Heating Plate Daylight	mm	300	300	300	800	300	300	300	950
Heating Plate Size	mm	550x550	650x650	750x750	1070x1070	500x500	600x600	650x650/700x700	810x810
Total Power	kW	42.2	53.6	58.4	57	45.5	54.5	58.2/60.0	128

Industry Application





Specialized Molding Machine for Energy Industry

Global Leader of Composite Insulation Product Molding Technology

Insulation Product Molding Machine for Energy Industry

Based on long-term close discussions with industry experts, customers, mold makers and material suppliers, we deeply understand features of various products, the needs of operators and managers, and provide leading solutions for various types and voltage products from 10kV to 1000kV. We create the best TCO for global customers, in return, we win orders globally far ahead of other manufacturers.

- With ownership of multiple independent intellectual property rights
- Special plasticizing and injection unit for silicone, perfectly avoid air trapping and compound scorch
- Safe and easy silicone stuffer
- High rigidity clamping unit, less flash at two sides even if the mold is very long
- Five clamping structures available for realizing the best molding solution and the highest production efficiency
- Siemens control system (4-10MS) with high execution speed, standard 10" screen; top brand hydraulic components
- Low energy consumption
- Easy to operate and user-friendly



Part Name: 10 kV Transformer
Number of Cavities: 1



Part Name: 11 kV Composite Insulator
Number of Cavities: 24



Part Name: 38 kV Arrester
Number of Cavities: 8



Part Name: 220 kV Hollow Core Insulator
Number of Cavities: 1



Part Name: 110kV Cone Type Hollow Core Insulator
Number of Cavities: 1



Part Name: 500 kV HV Composite Insulator
Number of Cavities: 2



Part Name: 20kV Composite Crossarm
Number of Cavities: 4



Part Name: 110kV Arrester
Number of Cavities: 1



Part Name: 11kV Cut-out
Number of Cavities: 16



Part Name: 10kV T Joint
Number of Cavities: 8



Specialized Molding Machine for Energy Industry

Global Leader of Composite Insulation Product Molding Technology



- YL2-ABL series adopts D1 upward clamping structure, which is relatively cost-effective.
- YL2-ATL series adopts D7 downward mold closing structure, which has more advantages for products that need multiple-step molding; at the same time, silicone stuffer is installed on the ground level, silicone block can be easily dropped inside.
- YL-H1000F is terrific for molding UHV hollow core insulator. It can efficiently produce hollow core insulators free of defects such as air bubble, heavy flash, non-filling. It adopts low pressure injection molding technology to protect FRP tubes. Its ease of operation, production efficiency and product quality are perfect.
- YL2-V360L is mainly used to produce low and medium voltage insulators, arresters and other types of insulation products.



YL2-ABL



YL2-ATL

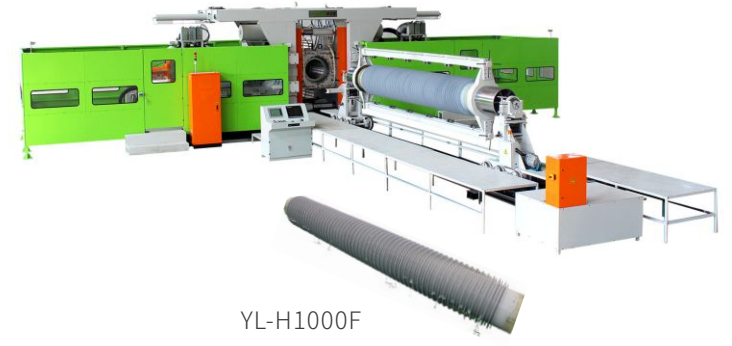

YL-H1000F



YL2-AT1800L



YL2-V360L



YL2-AT1100L



YL2-AB900L



YL-C80I

Machine Specifications

	Unit	YL2-V360L	YL2-AB500/550L	YL2-AB650L	YL2-AB900L
Clamping Structure		D2	D1	D1	D1 (2-cylinder)
Clamping Force	kN	3600	5000/5500	6500	4500x2
Closing Stroke	mm	500	600	700	600
Heating Plate Size	mm	630x1300	630x1500	800x1700	850x2000
Heating Plate Heating Power	kW	33	36/44	53/60	82
Standard Injection Unit	cm ³	L3R-4000B2	L1R-10000A	L1R-15000B	L1R-15000B
Optional Injection Unit	cm ³	L3R-5000B2	L1R-15000B / L1R-20000B / L1R-25000C	L1R-20000B / L1R-25000C	L1R-20000B / L1R-25000C

	YL2-AT550L	YL2-AT660L	YL2-AT880L	YL2-AT1100L	YL2-AT1800L
Clamping Structure	D7	D7	D7	D7 (2-cylinder)	D7 (2-cylinder)
Clamping Force	5500	6600	8800	5500x2	8800x2
Closing Stroke	700	800	1200	700	1200
Heating Plate Size	630x1500	650x1600	800x1600	800x2600	1000x2600
Heating Plate Heating Power	36/44	45	55	80	120
Standard Injection Unit	L1R-15000B	L1R-18000C	L1R-25000C	L1R-25000C	L1R-50000D
Optional Injection Unit			L1R-32000D	L1R-32000D	L1R-50000E / L1R-60000E



LSR Cable Accessories Clamping Molding Machine

Full Range of Optimal Molding Solutions

- Both horizontal and vertical structure available for different products
- Clamping force can be controlled in multiple stages according to time
- With ownership of independent intellectual property rights in the respect of horizontal clamping unit



YL-H160/YL-H250



YL-V360



YL-V300



YL-V100

Industry Application

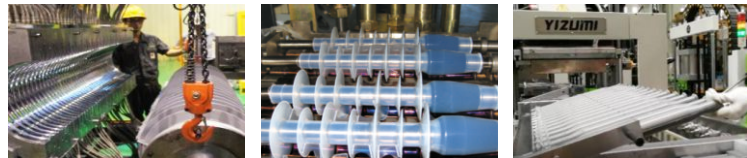
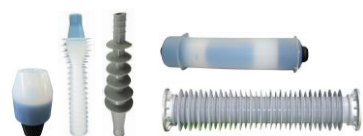

Air Spring Molding Machine

Meet European Process and Performance Requirements

- In line with the advanced molding process and performance requirement of European air spring
- With ownership of independent intellectual property rights in the respect of four tie-bar, two-step downward closing clamping structure
- Self-programming, users can freely edit the production process according to their needs

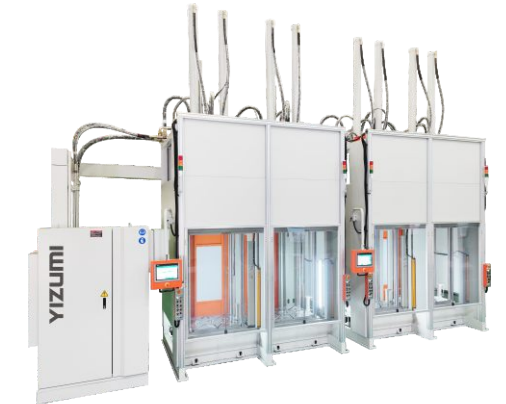

YL-V50
Rolling lobe air spring molding machine

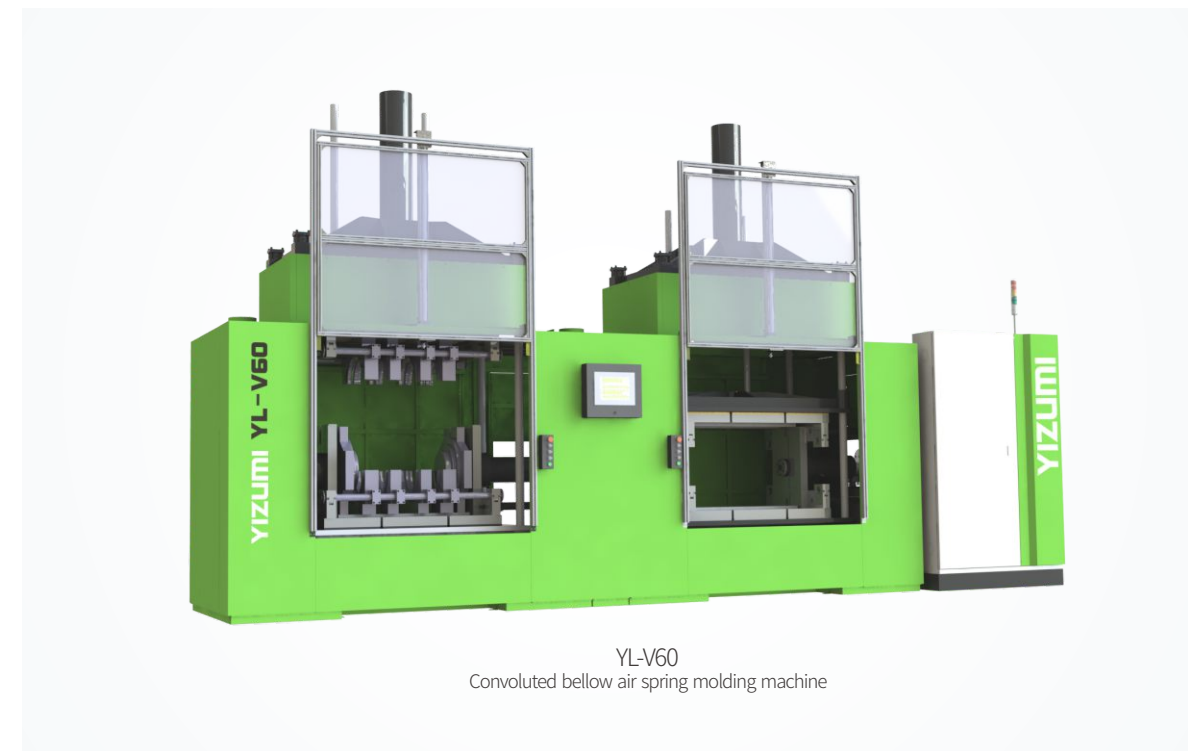

YL-V60
Convoluted bellow air spring molding machine



Joint-free Rubber Track Molding Machine

Worldwide First, Advanced Technology

- 1st stage & 2nd stage molding can be done in one machine, easy for production planning and less mold cost
- Suitable for agricultural track and engineering track production
- Closed-loop control of dynamic tensioning function, and closed-loop control of tensioning force and position, the steel belt will not appear trumpet state
- Convenient for accurate placement of insert and rubber
- Specially-made trolley easy for demolding, convenient for inspection, trimming, turning and transferring
- Multiple hydraulic pumps, short cycle time



YL-E520



YL-E360

Machine Specifications

	Unit	YL-E200	YL-E360	YL-E520
Clamping Force	Ton	200	360	520
Heating Plate Dimension	mm	1350x500/900x500	1630x640/1430x640	2060x750/1750x750
Mould Open Stroke	mm	450	450	460
Distance Between Heating Plates	mm	520/550	550/550	560/580
Min.Mould Thickness	mm	110	120	120
Max.Width of Track	mm	150-300	300-500	350-600
Range of Track	mm	2500-3800	4140-5040	4770-6670
System Pressure	bar	200	200	200



Diamond Wire Saw Molding Machine

Tailor-made Solutions for Global Industry

- Professional molding technologies
- Ideal for molding rubber wire saw without end connection
- High injection pressure, secure the bonding between diamond beads and steel wires
- Applicable for multi-cavity mold, high production efficiency
- Siemens control system, German variable pump
- Adopt D2 upward clamping structure, with L3R injection unit fixed on the top, the machine can run stably at opening stroke 480mm



YL2-V250L

- Especially designed downward clamping structure, the molding cavities distribute at the external side of tie bar with uniform force, ideal for molding circular TPU diamond wire saw
- Bigger clamping force for higher injection pressure, ensure better bonding between diamond beads and steel wires
- Using the control system and servo motor pump from vertical injection molding machine, high control accuracy, low energy consumption and low noise
- Multiple auxiliary equipment interface, well-equipped functions



YL2-V200F-P



Molds

Yizumi has an elite technical team to provide injection mold solutions, cold runner and mold solutions.

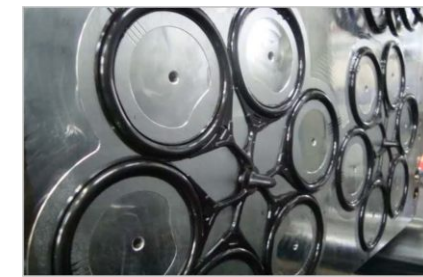
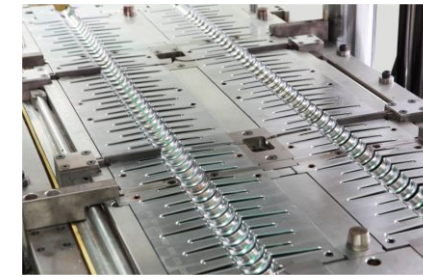
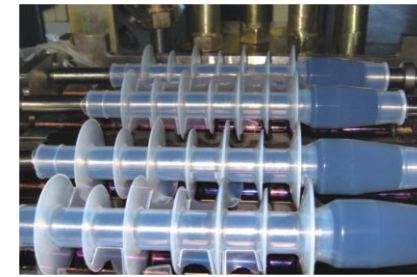
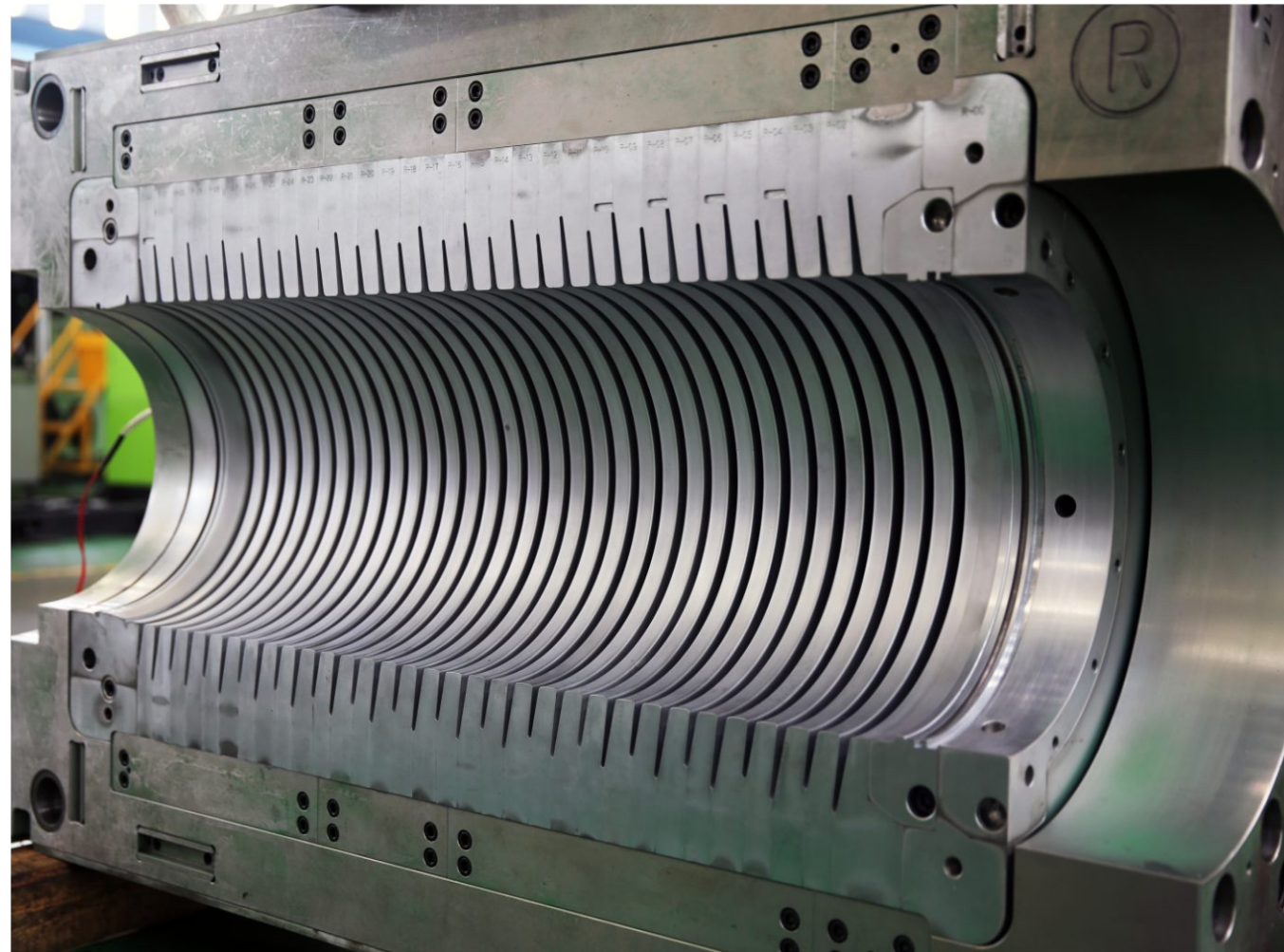

YIZUMI Factory Outlet Service

YFO (Yizumi Factory Outlet) model ensures quick response and controllability of the service and it is also Yizumi's new global service strategy for the future. As regards the service concept, we not only ensure the safety of customer's production activity, but also endeavor to fulfill the ultimate goal of reducing the risk of downtime through every detail and improving customer's productivity.

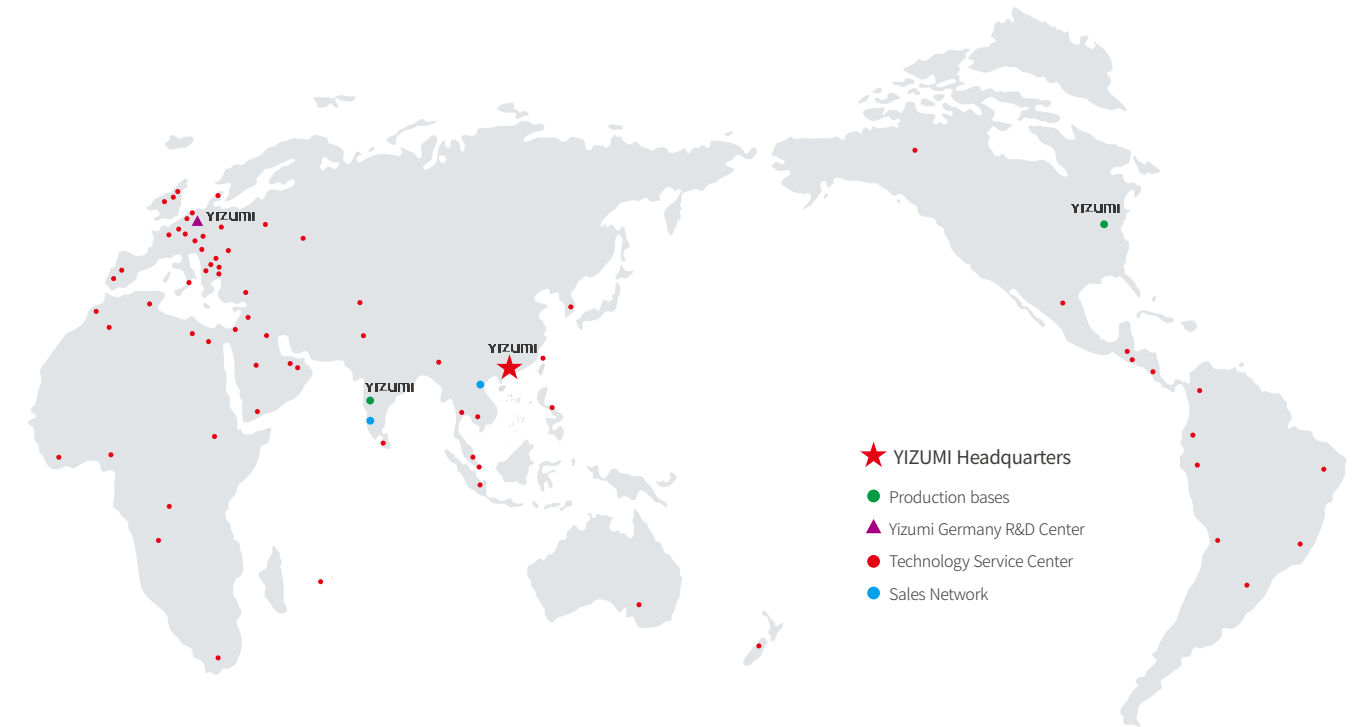

YFO Service Experience

<p>Call Review</p> <p>Establish customer files and provide consulting and guidance services through the return visit mechanism.</p>	<p>On Site Checking</p> <p>Service engineer will check the machine regularly and provide preventive maintenance.</p>	<p>Spare Parts</p> <p>We provide customers with a convenient spare parts supply network to ensure the smooth, timely and accurate delivery of spare parts.</p>
<p>Training</p> <p>Carry out targeted training for professionals and customers.</p>	<p>Rating Evaluation</p> <p>We conduct service rating certification for YFO service engineers and strictly regulate service standards.</p>	<p>24hrs Service</p> <p>365 days, 24 hours exclusive hotline, with maintenance experts responding to your needs.</p>

Service Networks and Spare Parts Center Worldwide

<p>246</p> <p>YFO service network covers 96 cities in China and 150 out of China.</p>	<p>6,000m²</p> <p>Spare parts stores across 96 cities in China and 23 out of China.</p>	<p>96%</p> <p>Parts same-day delivery rate at headquarters ≥96%.</p>
--	---	---

